



---

## UNIT 2: FIRE SAFETY

---

---

### In this unit you will learn about:

- **Fire Chemistry:** How fire occurs, classes of fire, and choosing the correct means to extinguish each type of fire.
- **Fire Hazards:** Potential fire hazards in the home and workplace, and fire prevention strategies.
- **Fire Safety:** How to evaluate fires, assess firefighting resources, and determine a course of action.
- **Portable Fire Extinguishers:** Types of portable fire extinguishers and how to operate them.
- **Fire Suppression Safety:** How to decide if you should attempt to extinguish a fire; how to approach and extinguish a fire safely.
- **Teamwork:** The importance of working with a buddy.
- **Hazardous Materials:** How to identify potentially dangerous materials in storage or in transit.



UNIT 2: FIRE SAFETY

---

**INTRODUCTION AND UNIT OVERVIEW**

During and immediately following a severe emergency, the first priorities of professional fire services are life safety and extinguishing *major* fires. They may be hampered by impassable roads, inadequate water supply, weather conditions, burning material, and inadequate resources.

CERTs play a very important role in fire safety by:

- Extinguishing small fires before they become major fires. This unit will provide training on how to use an extinguisher to put out small fires—and how to recognize when a fire is too big to handle.
- Preventing additional fires by removing fuel sources. This unit will also describe how to ensure that a fire, once extinguished, is completely extinguished.
- Shutting off utilities, when necessary and safe to do so.
- Assisting with evacuations where necessary. When a fire is beyond the ability of CERTs to extinguish, CERT members need to protect life safety by evacuating the area, when necessary, and establishing a perimeter.

CERT members help in fire-related emergencies when professional responders (paid and volunteer) are delayed. When responding, CERT members should keep in mind the following CERT standards:

- Rescuer safety is always the number one priority. Therefore, CERT members always:
  - Work with a buddy.
  - Wear safety equipment (gloves, helmet, goggles, mask, and boots).
- The CERT goal is to do the greatest good for the greatest number.

**INTRODUCTION AND UNIT OVERVIEW (CONTINUED)****UNIT OBJECTIVES**

At the end of this unit, you should be able to:

- Explain the role that CERTs play in fire safety.
- Identify and reduce potential fire risks in the home and workplace.
- Conduct a basic sizeup for a fire emergency.
- Understand minimum safety precautions, including:
  - Safety equipment.
  - Utility control.
  - Buddy system.
  - Back-up teams.
- Identify locations of hazardous materials in the community and the home, and reduce the risk from hazardous materials in the home.
- Extinguish small fires using a fire extinguisher.

The unit will provide you with the knowledge and skills that you will need to reduce or eliminate fire hazards and extinguish small fires. The areas that you will learn about include:

- How fires start and what keeps them burning.
  - Identification of fire hazards in the home, neighborhood, and workplace.
  - How to conduct a fire assessment, or sizeup.
  - The main firefighting resources that are available to CERTs and how to use them.
  - Procedures for safe firefighting.
  - Hazardous materials identification.
-

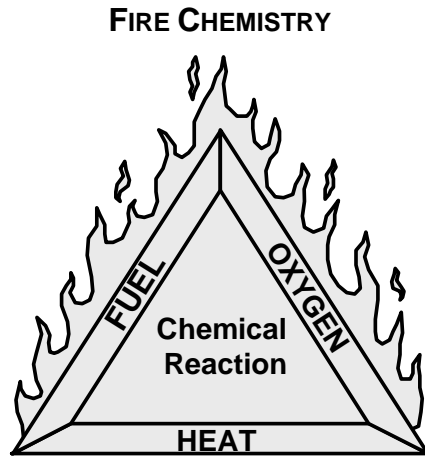

**Fire Triangle:** Fuel, oxygen, and heat create a chemical reaction, which causes fire.

Fire requires three elements to exist:

- Heat: Heat is required to elevate the temperature of a material to its ignition point.
- Fuel: The fuel for a fire may be a solid, liquid, or gas. The type and quantity of the fuel will determine which method should be used to extinguish the fire.
- Oxygen: Most fires will burn vigorously in any atmosphere of at least 20 percent oxygen. Without oxygen, most fuels could be heated until entirely vaporized, yet would not burn.

Working together, these three elements, called the *fire triangle*, create a chemical exothermic reaction, which is fire.

If any of these elements is missing or if any is taken away, fire will not occur or will extinguish.

**FIRE CHEMISTRY (CONTINUED)**

To aid in extinguishing fires, fires are categorized into classes based on the type of fuel that is burning:

- **Class A Fires:** Ordinary combustibles such as paper, cloth, wood, rubber, and many plastics
- **Class B Fires:** Flammable liquids (e.g., oils, gasoline) and combustible liquids (e.g., charcoal lighter fluid, kerosene) (These fuels burn only at the surface because oxygen cannot penetrate the depth of the fluid. Only the vapor burns when ignited.)
- **Class C Fires:** Energized electrical equipment (e.g., wiring, motors). (When the electricity is turned off, the fire becomes a class A fire.)
- **Class D Fires:** Combustible metals (e.g., aluminum, magnesium, titanium)

It is extremely important to identify the type of fuel to select the correct method and agent for extinguishing the fire.

---

**REDUCING FIRE HAZARDS IN THE HOME AND WORKPLACE**

Part of CERT planning is to identify hazards in the area that would affect residents in an emergency. This information is important to professional responders when they arrive on scene.

Each of us has some type of fire hazard in our home or workplace. Most of these hazards fall into three categories:

- Electrical hazards
- Natural gas hazards
- Flammable or combustible liquids

Homes and workplaces can and do have other hazards, including incompatible materials stored in close proximity to each other.

Simple fire prevention measures will go far in reducing the likelihood of fires:

- First, *locate* potential sources of ignition.
- Then, do what you can to *reduce or eliminate* the hazards.

**REDUCING FIRE HAZARDS IN THE HOME AND WORKPLACE (CONTINUED)**

**ELECTRICAL HAZARDS**

Simple ways that common electrical hazards can be reduced or eliminated include:

- Avoid the “electrical octopus.” Eliminate tangles of electrical cords. Don’t overload electrical outlets. Don’t plug power strips into other power strips.
- Don’t run electrical cords under carpets.
- Replace broken or frayed cords immediately.
- Maintain electrical appliances properly. Repair or replace malfunctioning appliances.

Emergencies sometimes occur despite our best efforts. In the event of an electrical emergency:

- Know where the power shutoffs for electrical appliances are.
- Know where the power shutoff for circuit breakers or fuses is and how to shut off the power.
- Unscrew individual fuses or switch off smaller breakers first, then pull the main switch or breaker.
- When turning the power back on, turn on the main switch or breaker first, then screw in the fuses or switch on the smaller breakers.

You should not enter a flooded basement to shut off the electrical supply, because water conducts electricity.

REDUCING FIRE HAZARDS IN THE HOME AND WORKPLACE (CONTINUED)

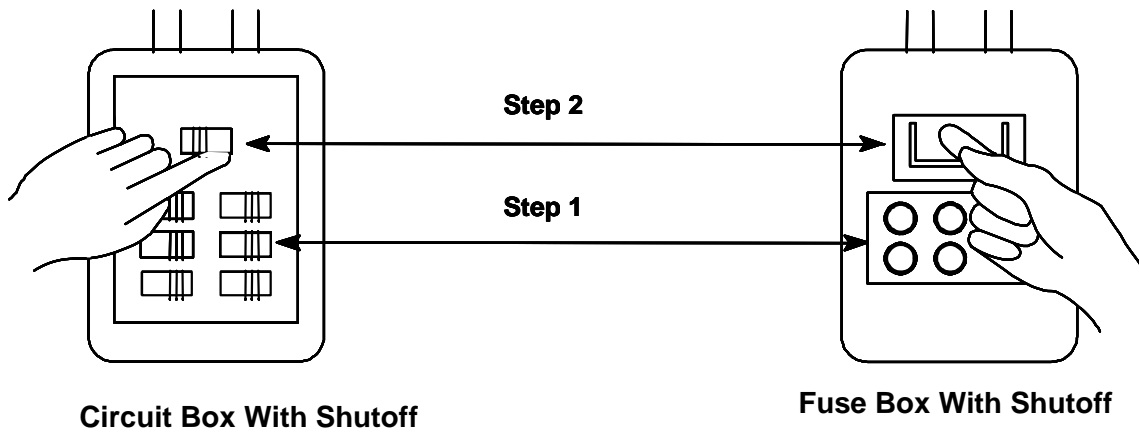

**Circuit box showing shutoff steps.**  
Step 1: Shut off individual breakers.  
Step 2: Shut off main breaker.

**Fuse box showing shutoff steps.**  
Step 1: Pull out individual fuses.  
Step 2: Pull out main fuse.

**NATURAL GAS HAZARDS**

Natural gas presents two types of hazards. It is an:

- Asphyxiant that robs the body of oxygen.
- Explosive that can easily ignite.

To reduce natural gas hazards:

- Install a natural gas detector near the furnace and hot water tank. Test the detector monthly to ensure that it works.
- Locate and label the gas shutoff valve(s). (There may be multiple valves inside a home in addition to the main shutoff.) Know how to shut off the gas and have the proper tool for shutting off the gas handy.



REDUCING FIRE HAZARDS IN HOME AND WORKPLACE (CONTINUED)

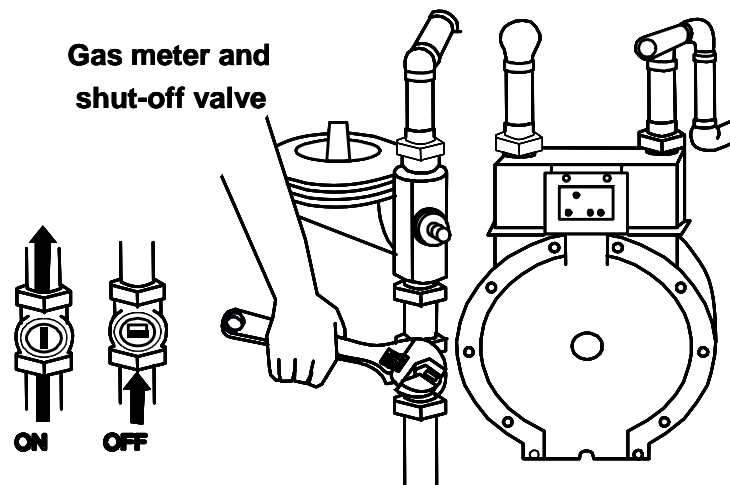

Natural Gas Meter With Shutoff

The gas meter shut-off diagram indicates the shut-off valve location on the pipe that comes out of the ground. To turn off the valve, use a wrench to turn the valve clockwise one-quarter turn.

**REDUCING FIRE HAZARDS IN HOME AND WORKPLACE (CONTINUED)**

In a disaster, if you smell gas, leave the building immediately. If there is a fire, turn off the gas from outside the building. After service is turned off, however, it can be restored only by a trained technician.

Never enter the basement of a structure that is on fire to turn off any utility.

**FLAMMABLE LIQUID HAZARDS**

To reduce hazards from flammable liquids:

- Read labels to identify flammable products.
- Store them properly, using the L.I.E.S. method covered in Unit 1.

You should extinguish a flammable liquid using a portable fire extinguisher rated for that class of fire. Ratings for portable extinguishers will be addressed later in this unit.

---

### CERT SIZEUP

CERT sizeup is a continual data-gathering process that will dictate whether to attempt fire suppression and planning for extinguishing the fire.

CERT sizeup answers the questions:

- Can my buddy and I fight the fire safely?
- Do my buddy and I have the right equipment?
- Are there other hazards?
- Is the building structurally damaged?
- Can my buddy and I escape?

Sizeup is a continual nine-step process that enables first responders to make decisions and respond appropriately in the areas of greatest need.

The nine steps in sizeup are:

1. Gather facts. What has happened? How many people are involved (if you know)? What is the current situation?
2. Assess and communicate the damage. Take a lap around the building. Try to determine what has happened, what is happening now, and how bad things can really get.
3. Consider probabilities. What is likely to happen? What could happen through cascading events?
4. Assess your own situation. Are you in immediate danger? Have you been trained to handle the situation? Do you have the equipment that you need?
5. Establish priorities. Are lives at risk? Can you help? Remember, life safety is the first priority!
6. Make decisions. Base your decisions on the answers to Steps 1 through 3 and in accordance with the priorities that you established.
7. Develop plans of action. Develop a plan that will help you accomplish your priorities. Simple plans may be verbal, but more complex plans should always be written.

**CERT SIZEUP (CONTINUED)**

8. Take action. Execute your plan, documenting deviations and status changes so that you can report the situation accurately to first responders.
  9. Evaluate progress. At intervals, evaluate your progress in accomplishing the objectives in the plan of action to determine what is working and what changes you may have to make to stabilize the situation.
-

CERT FIRE SIZEUP CHECKLIST

	Yes	No
<b>Step 1: Gather Facts</b>		
<i>Time</i>		
▪ Does the time of day or week impact fire suppression efforts?	<input type="checkbox"/>	<input type="checkbox"/>
How?		
 <i>Weather</i>		
▪ Will weather conditions impact your safety?	<input type="checkbox"/>	<input type="checkbox"/>
If yes, how will your safety be affected?		
▪ Will weather conditions affect the fire situation?	<input type="checkbox"/>	<input type="checkbox"/>
If yes, how will the fire situation be affected?		
 <i>Type Of Construction</i>		
▪ What type(s) of structure(s) are involved?		
▪ What type(s) of construction are involved?		

**COMMUNITY EMERGENCY RESPONSE TEAM**

**UNIT 2: FIRE SAFETY**

**CERT FIRE SIZEUP CHECKLIST**

	<b>Yes</b>	<b>No</b>
<b>Step 1: Gather Facts (Continued)</b>		
<i>Occupancy</i>		
▪ Are the structures occupied?	<input type="checkbox"/>	<input type="checkbox"/>
If yes, how many people are likely to be affected?		
▪ Are there special considerations (e.g. children, elderly)?	<input type="checkbox"/>	<input type="checkbox"/>
<i>Hazards</i>		
▪ Are hazardous materials involved?	<input type="checkbox"/>	<input type="checkbox"/>
▪ Are any other types of hazards likely to be involved?	<input type="checkbox"/>	<input type="checkbox"/>
If yes, what other hazards?		
<b>Step 2: Assess and Communicate the Damage</b>		
▪ Take a lap around the building. Is the damage beyond the CERT team's capability?	<input type="checkbox"/>	<input type="checkbox"/>
▪ Are normal communication channels functioning?	<input type="checkbox"/>	<input type="checkbox"/>

CERT FIRE SIZEUP CHECKLIST

	Yes	No
<b>Step 3: Consider Probabilities</b>		
<i>Life Hazards</i>		
▪ Are there potentially life-threatening hazards?	<input type="checkbox"/>	<input type="checkbox"/>
If yes, what are the hazards?		
 <i>Path of Fire</i>		
▪ Does the fire's path jeopardize other areas?	<input type="checkbox"/>	<input type="checkbox"/>
If yes, what other areas may be jeopardized?		
 <i>Additional Damage</i>		
▪ Is there a high potential for more disaster activity that will impact personal safety?	<input type="checkbox"/>	<input type="checkbox"/>
If yes, what are the known risks?		
 <b>Step 4: Assess Your Own Situation</b>		
▪ What resources are available with which you can suppress the fire?		
▪ What equipment is available?		

**COMMUNITY EMERGENCY RESPONSE TEAM**

**UNIT 2: FIRE SAFETY**

**CERT FIRE SIZEUP CHECKLIST**

	<b>Yes</b>	<b>No</b>
<b>Step 5: Establish Priorities</b>		
▪ Can fire suppression be <i>safely</i> attempted by CERT members?	<input type="checkbox"/>	<input type="checkbox"/>
<u>If no, do <i>not</i> attempt suppression.</u>		
▪ Are there other, more pressing needs at the moment?	<input type="checkbox"/>	<input type="checkbox"/>
If yes, list.		

**Step 6: Make Decisions**

- Where will deployment of available resources do the most good while maintaining an adequate margin of safety?

**Step 7: Develop a Plan of Action**

- Determine how personnel and other resources should be deployed.



CERT FIRE SIZEUP CHECKLIST

**Step 8: Take Action**

- Put the plans into effect.

**Step 9: Evaluate Progress**

- Continually size up the situation to identify changes in the:
  - Scope of the problem.
  - Safety risks.
  - Resource availability.
- Adjust strategies as required.

**FIREFIGHTING RESOURCES**

The most common firefighting resources are:

- Portable fire extinguishers.
- Interior wet standpipes.

Portable fire extinguishers are invaluable for putting out small fires. A well-prepared home or workplace will have at least two portable fire extinguishers.

Interior wet standpipes are usually found in commercial and apartment buildings and consist of 100 feet of 1½-inch jacketed hose with a ¾-inch nozzle tip. They deliver up to 125 gallons of water per minute.

Always work in three-person teams when using an interior wet standpipe. One person handles the hose, another bleeds the air from the line, and the third person controls the water pressure.

There are also other firefighting resources available that are less common:

- In interior spaces, it is possible to *confine* a fire and restrict the spread of smoke and heat by closing doors to rooms and hallways.
- Other *creative* resources may also be available:
  - Swimming pool or spa water and buckets
  - Sand or dirt and shovels
  - A garden hose

The type of fuel that is burning will determine which resources to select to fight a fire.

**EXTINGUISHER RATING AND LABELING**

Portable fire extinguishers must be rated and approved by the State Fire Marshal and Underwriters Laboratories. They are rated according to their effectiveness on the different classes of fire. Their strength and capability must also be labeled by the manufacturer.

The label contains vital information about the type(s) of fire for which the extinguisher is appropriate.

**FIREFIGHTING RESOURCES (CONTINUED)**

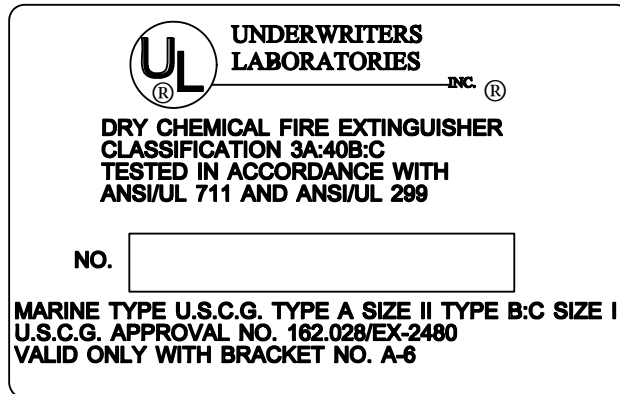

**Manufacturer's Label**

Sample Manufacturer's Label for a fire extinguisher, showing the Underwriters Laboratories Symbol at the top, the type and classification of fire extinguisher, testing procedures used, and serial number. At the bottom of the label is marine information, including the U.S. Coast Guard approval number.





**TYPES OF FIRE EXTINGUISHERS**

There are four types of extinguishers:

- Water
- Dry chemical
- Carbon dioxide
- Specialized fire extinguishers

**FIREFIGHTING RESOURCES (CONTINUED)**

**Fire Types, Extinguishing Agents, and Methods**

Fire Type	Extinguishing	
	Agent	Method
<b>Ordinary Solid Materials</b>  <b>A</b>	Water	Removes heat
	Foam	Removes air and heat
	Dry chemical	Breaks chain reaction
<b>Flammable Liquids</b>  <b>B</b>	Foam CO <sub>2</sub>	Removes air
	Dry chemical	Breaks chain reaction
<b>Electrical Equipment</b>  <b>C</b>	CO <sub>2</sub>	Removes air
	Dry chemical	Breaks chain reaction
<b>Combustible Metals</b>  <b>D</b>	Special agents	Usually remove air

### FIREFIGHTING RESOURCES (CONTINUED)

Common characteristics of water extinguishers include:

- Capacity. Standard size is 2½ gallons.
- Range. Standard range is 30-40 feet.
- Pressure. Standard pressure is 110 pounds per square inch (psi).

Use extreme caution when using a water extinguisher to ensure that the water, which is under pressure, does not scatter lightweight materials and spread the fire.

Dry chemical extinguishers are also common.

- Dry chemical extinguishers have a sodium bicarbonate base and are effective on Class B and C fires.
- Multipurpose dry chemical extinguishers have a monoammonium phosphate base and are effective for Class A, B, and C fires.

Common characteristics of dry chemical extinguishers include:

- Capacity. Approximately 10-20 seconds discharge time.
- Range. Standard range is 8-12 feet.
- Pressure. Standard range is 175-250 psi.

While still in use, carbon dioxide and other specialized extinguishers are becoming less common.

### DECIDING TO USE A FIRE EXTINGUISHER

There are a series of questions that you should ask yourself before attempting to fight a fire with a fire extinguisher.

If you answer “NO” to any of these questions, you should:

- Leave the building immediately.
- Shut all doors as you leave to slow the spread of the fire.

If all of the answers to the questions are “YES,” you may attempt to extinguish the fire. Even if you answer “YES” to all of the questions, but feel unable to extinguish the fire, you should leave immediately.

**FIREFIGHTING RESOURCES (CONTINUED)**

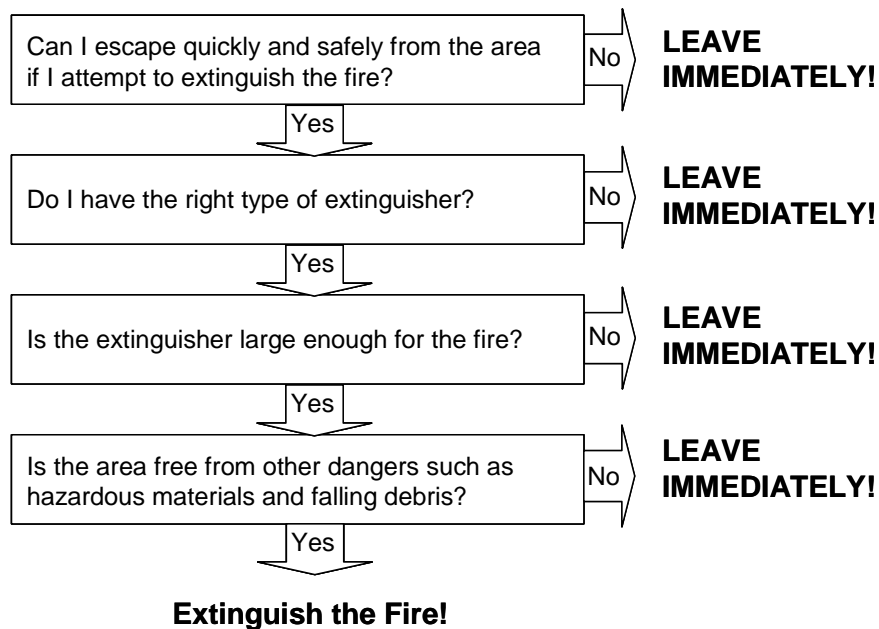

**Deciding to Use a Fire Extinguisher**

A flowchart illustrates the decisionmaking process for determining whether to use a fire extinguisher. The decision is based on four questions:

- Can I escape quickly and safely if I attempt to extinguish the fire?
- Do I have the right type of extinguisher?
- Is the extinguisher large enough for the fire?
- Is the area free from other dangers such as hazardous materials and fallen debris?

If the answer to all questions are “yes,” CERT members should attempt to extinguish the fire. If the answer to any questions are “no,” CERT members should leave.

**FIREFIGHTING RESOURCES (CONTINUED)**

**OPERATING A FIRE EXTINGUISHER**

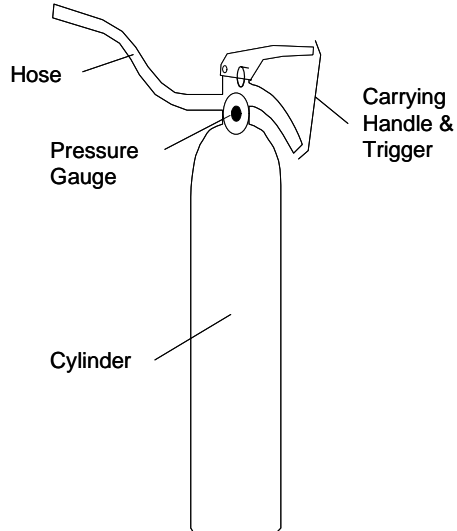

**Components of a Portable Fire Extinguisher**

**Components of a portable fire extinguisher: Hose, carrying handle and trigger, pressure gauge, cylinder**

A portable fire extinguisher includes four components:

- A pressure gauge
- A hose
- A cylinder
- A carrying handle with trigger

You should always operate portable fire extinguishers in an upright position.

The acronym for operating a fire extinguisher is P.A.S.S.:

- Pull
- Aim
- Squeeze
- Sweep

To ensure that the extinguisher is working properly, test it before approaching any fire.

FIREFIGHTING RESOURCES (CONTINUED)

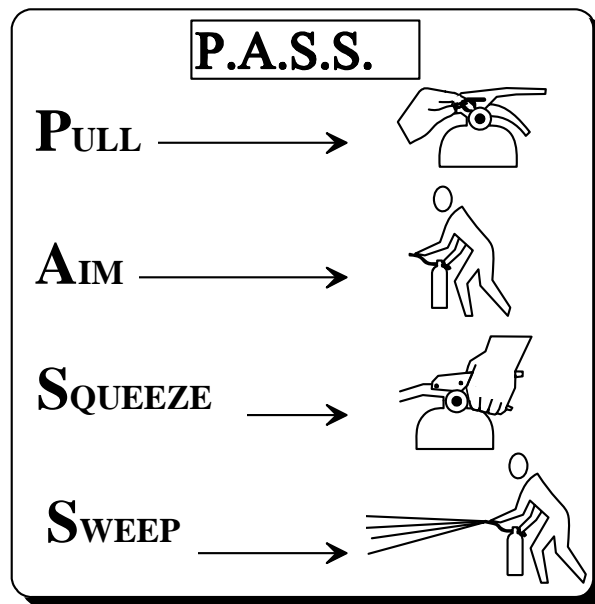

P.A.S.S

PASS: Pull, Aim, Squeeze, Sweep

Aim at the base of the fire.

---

**FIRE SUPPRESSION SAFETY**

As a CERT member, fire suppression will be one of your roles. However, even following a disaster, your personal safety must be your number one concern. You will be unable to help anyone if you are injured through careless sizeup or unsafe acts.

Fire suppression safety rules include:

- Use safety equipment at all times. Wear your helmet, goggles, dust mask, leather gloves, and heavy shoes. If you are not equipped to protect your personal safety, leave the building.
- Work with a buddy. Buddies serve an important purpose. They protect your safety. Don't ever try to fight a fire alone.
- Have a backup team, whenever possible. A backup team just makes good sense. A backup team can support your fire suppression efforts and can provide help if you need it.



**FIRE SUPPRESSION SAFETY (CONTINUED)**

- Always have two ways to exit the fire area. Fires spread much faster than you might think. Always have a backup escape plan in case your main escape route becomes blocked.
- Feel closed doors with the back of the hand, working from the bottom of the door up. Do not touch the door handle before feeling the door. If the door is hot, there is fire behind it. Do not enter! Opening the door will feed additional oxygen to the fire.
- Confine the fire, whenever possible, by keeping doors closed.
- Stay low to the ground. Smoke will naturally rise. Keeping low to the ground will provide you with fresher air to breathe.
- Maintain a safe distance. Remember the effective range of your fire extinguisher. Don't get closer than necessary to extinguish the fire.
- Overhaul the fire to be sure that it is extinguished—and stays extinguished.

What CERTs don't do when suppressing fires is as important as what they should do. DON'T:

- Get too close. Stay near the outer range of your extinguisher. If you feel the heat, you are too close.
  - Try to fight a fire alone. Remember that your first priority is your personal safety. Don't put yourself at risk.
  - Try to suppress large fires. Learn the capability of your equipment, and do not try to suppress a fire that is clearly too large for the equipment at hand (i.e., a fire that is larger than the combined ratings of available fire extinguishers).
  - Enter smoke-filled areas. Fire suppression in smoke-filled areas requires equipment that CERTs don't have.
-

**HAZARDOUS MATERIALS**

Materials are considered hazardous if they have any of these characteristics listed below:

- Corrode other materials.
- Explode or are easily ignited.
- React strongly with water.
- Are unstable when exposed to heat or shock.
- Are otherwise toxic to humans, animals, or the environment.

Hazardous materials include, but are not limited to:

- Explosives.
- Flammable gases and liquids.
- Poisons and poisonous gases.
- Corrosives.
- Nonflammable gases.
- Oxidizers.
- Radioactive materials.

Knowledge that hazardous materials are present helps to protect CERT members' safety and is also valuable sizeup information for first responders.

Hazardous materials pose an ever-present danger. They are stored in all types of locations and are transported by a variety of means.

**HAZARDOUS MATERIALS (CONTINUED)**

**IDENTIFYING STORED HAZARDOUS MATERIALS**

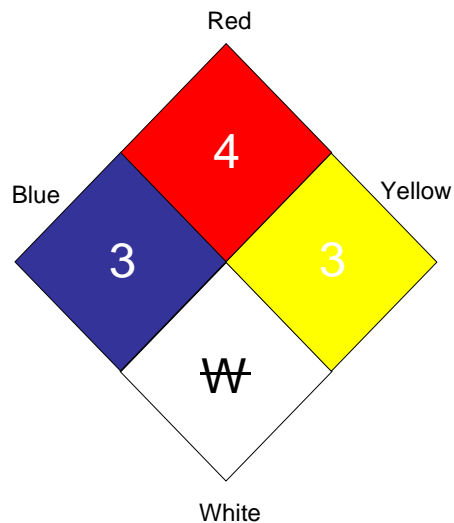

**National Fire Protection Association 704 Diamond**

The NFPA 704 Diamond, showing four quadrants and hazard ratings.

The figure above is an NFPA 704 Diamond—the identification system instituted by the National Fire Protection Association. The NFPA 704 Diamond is a concise system for identifying the hazards associated with specific materials. This placard would be found on a fixed facility.

The diamond is divided into four colored quadrants, each with a rating number inside of it, and that number indicates the degree of risk associated with the material. **The higher the number, the higher the risk!**

**NFPA 704 Diamond**

- The red quadrant describes the material's flammability.
- The blue quadrant indicates health hazard.
- The yellow quadrant indicates reactivity.

COMMUNITY EMERGENCY RESPONSE TEAM

UNIT 2: FIRE SAFETY

HAZARDOUS MATERIALS (CONTINUED)

Quadrant	Rating	Meaning
<b>White</b>	W	Indicates a material that shows unusual reactivity with water (i.e., should never be mixed with water or have water sprayed on it). <u>Magnesium metal</u> is an example of a material that is reactive to water.
	OX	Indicates a material that possesses oxidizing properties. <u>Ammonium nitrate</u> is an example of a material with oxidizing properties.
	ACID	Indicates that the material is an acid.
	ALK	Indicates that the material is a base.
	COR	Indicates that the material is corrosive.
		Indicates that the material is radioactive.

The numbers within the 704 Diamond are for professional firefighter use only. CERT members should consider these placards a “stop sign.” The only action CERT members should take when a facility is placarded with an NFPA 704 Diamond is to evacuate persons who are downwind, as necessary, to an uphill and upwind location.

HAZARDOUS MATERIALS (CONTINUED)

IDENTIFYING HAZARDOUS MATERIALS IN TRANSIT

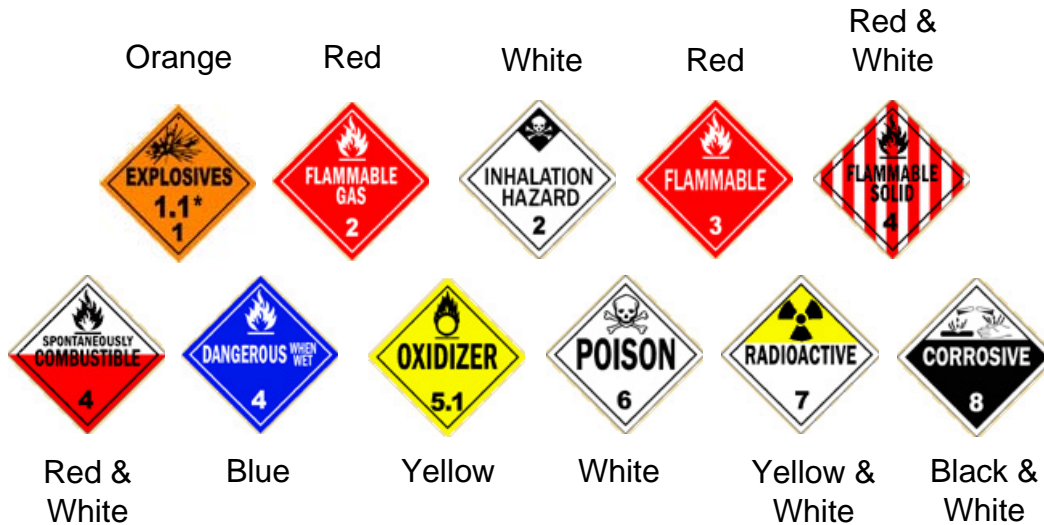

DOT Warning Placards

DOT Warning Placards: 1.1, Explosives; 2, Flammable Gas; 2, Inhalation Hazard; 3, Flammable; 4, Flammable Solid; 4, Spontaneously Combustible; 4, Dangerous When Wet; 5.1, Oxidizer; 6, Poison; 7, Radioactive; and 8, Corrosive.

These are Department of Transportation (DOT) placards. The DOT placard is one of three ways that hazardous materials are marked and identified while in transit. The other two ways are:

- The United Nations (UN) system.
- The North American (NA) warning placards.

HAZARDOUS MATERIALS (CONTINUED)

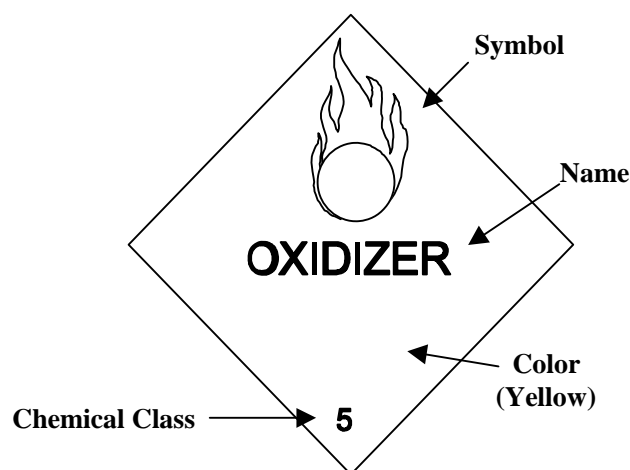

UN Placarding System

UN Placarding System, showing the hazard class in the bottom corner, the chemical category in the center, and the hazard symbol at the top of the placard.

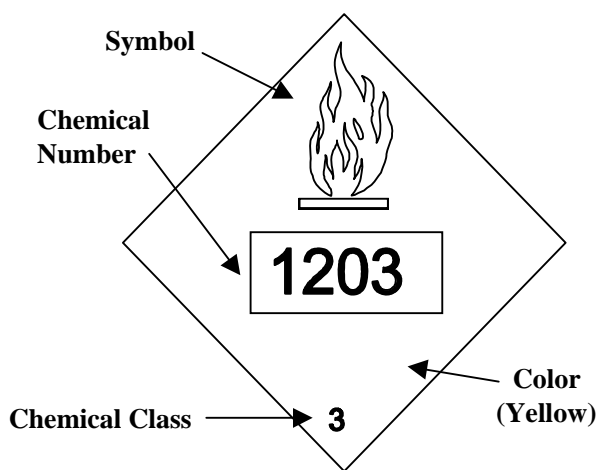

NA Numbering System

NA Numbering System, showing the hazard class in the bottom corner, the chemical number in a white box in the center, and the hazard symbol at the top of the placard.

These placards can be on any vehicle, not only tankers. Also:

- No placard is required for less than 1,000 pounds of many hazardous materials.
- Certain hazardous materials (e.g., anhydrous ammonia) are placarded as a nonflammable gas for domestic transport but as a flammable gas for international transport. (Anhydrous ammonia is a flammable gas!)
- Sometimes drivers forget to change the placard when they change their cargo. The group should use extreme caution when approaching any vehicle in an accident.

The DOT placard color is also significant.

You should always err on the side of safety. Do not assume that, because there is no placard, no hazardous materials are present.

- Talk to drivers or train crew members whenever possible.
- Treat any unknown situation as a hazardous materials incident.

Like the NFPA 704 Diamond, the DOT, UN, and NA placards should be a “stop sign” for CERT members.

**EXERCISE: SUPPRESSING SMALL FIRES**

**Purpose:** This exercise will provide you with experience in two key areas of fire suppression:

- Using a portable fire extinguisher to suppress a small fire
- Applying teamwork to fire suppression

**Instructions:** Follow the steps below to complete this exercise.

1. Work in two-person teams. Team members must communicate with each other. The emphasis is on safety and teamwork.
2. Each team member will be provided with a portable fire extinguisher.
3. Team Member 1 should assume the “ready” position, with pin pulled, extinguisher aimed and upright, approximately 20 to 25 feet from the fire.

**When ready to approach the fire, Team Member 1 should say, “Ready.” Team Member 2 should repeat, “Ready.”**

**As Team Member 1 begins to move forward, he or she should say, “Going in.” Team Member 2 should repeat the command and stay within reach of Team Member 1.**

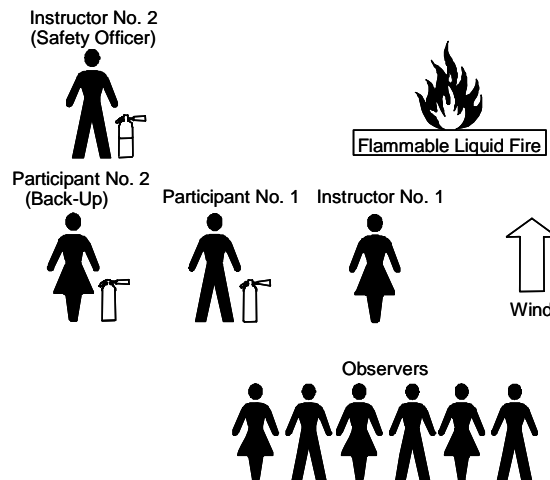

**Both team members should walk toward the fire. Team Member 1 should watch the fire and Team Member 2 should stay close to Team Member 1, keeping his or her hand on Team Member 1’s shoulder. Team Member 2’s job is to protect Team Member 1.**

4. Team Member 1 should approach the fire from the windward side (i.e., with the wind to the team member’s back). When approximately 10 feet from the fire, Team Member 1 should begin to discharge the extinguisher at the base of the fire, continuing the approach until the range for the extinguisher is optimal.

**EXERCISE: SUPPRESSING SMALL FIRES (CONTINUED)**

5. Team Member 1 should sweep the base of the fire until it is extinguished.

**When Team Member 1 is exiting the fire area, he or she should say, “Backing out.” Team Member 2 should repeat the command. Participant 2 should guide Participant 1 from the area with his or her hands as Participant 1 continues facing the fire and looking for hazards.**

After the fire is extinguished, trade positions and repeat the exercise.

---



### UNIT SUMMARY

Effective fire suppression depends on an understanding of:

- The type of fuel involved.
- The elements required for fire to exist.
- The class of fire.
- The resources required and available to extinguish each type of fire.
- Effective fire suppression techniques.

Fire requires heat, fuel, and oxygen to exist.

There are four types, or classes, of fire:

- Class A: Ordinary combustibles
- Class B: Flammable liquids
- Class C: Energized electrical equipment
- Class D: Combustible metals

It is extremely important to identify the class of fire to select the proper extinguisher for the class.

To help understand the types of materials, there are several methods of placarding hazardous materials being stored or transported, including NFPA, DOT, UN, and NA. When faced with accidents involving materials that are placarded as hazardous—or when the material is unknown—keep away and call for professional help immediately.

Portable fire extinguishers are most frequently used for suppressing small fires. Their labels tell the types of fires for which they are effective and the area that they can suppress.

**UNIT SUMMARY (CONTINUED)**

When using portable fire extinguishers, remember P.A.S.S.: Pull, Aim, Squeeze, and Sweep.

When suppressing a fire, always follow the safety rules established for CERTs.

**HOMEWORK ASSIGNMENT**

Before the next session, you should:

- Read and familiarize yourself with Unit 3: Emergency Medical Operations—Part I in the Participant Manual.
- Obtain and bring to the session:
  - 1 box of 4" × 4" bandages.
  - 1 triangular bandage.
  - 1 roll of roller gauze.
  - 1 medical mask.
  - 1 pair of examination gloves.
  - 1 blanket.

Wear comfortable clothes for the next session because you will be practicing medical techniques.

---